

Ambient condition:

1. Temperature: -25℃~65℃
2. Relative humidity: ≤ 90%
3. Atmospheric pressure: 55Kpa(4000m)
4. Vibration: 10~55Hz, double amplitude: 1.5mm
5. Impact: 150m/s²(Peak acceleration)

Number of blades=7

Nominal data:

Voltage	48VDC
Voltage range	36~57VDC
Current draw	1.1A
Power input	52W
Speed	2950r/min
Airflow	9.0 m ³ /min
Static pressure	380Pa
Noise level	65dB(A)
Mass	1.22kg
Life time(40℃)	40,000 hours

Characteristics:

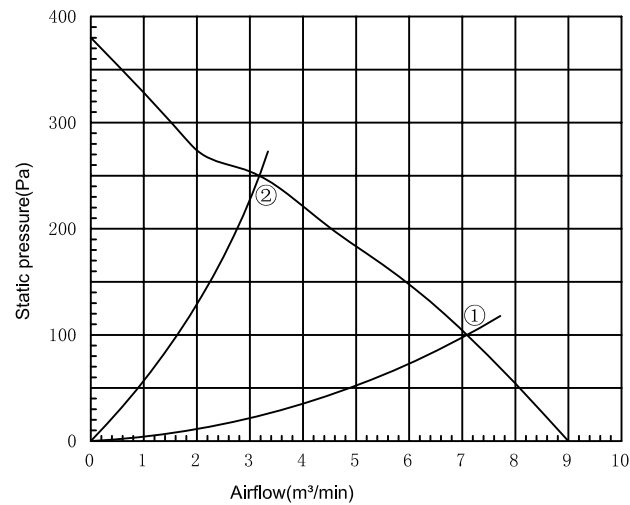

Wiring diagram:

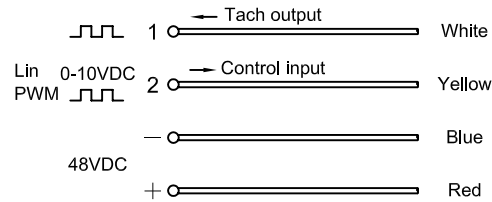

Operating zone:

Point	Speed	Static pressure	Airflow
①	2850r/min	100Pa	7.1m ³ /min
②	2800r/min	250Pa	3.2m ³ /min

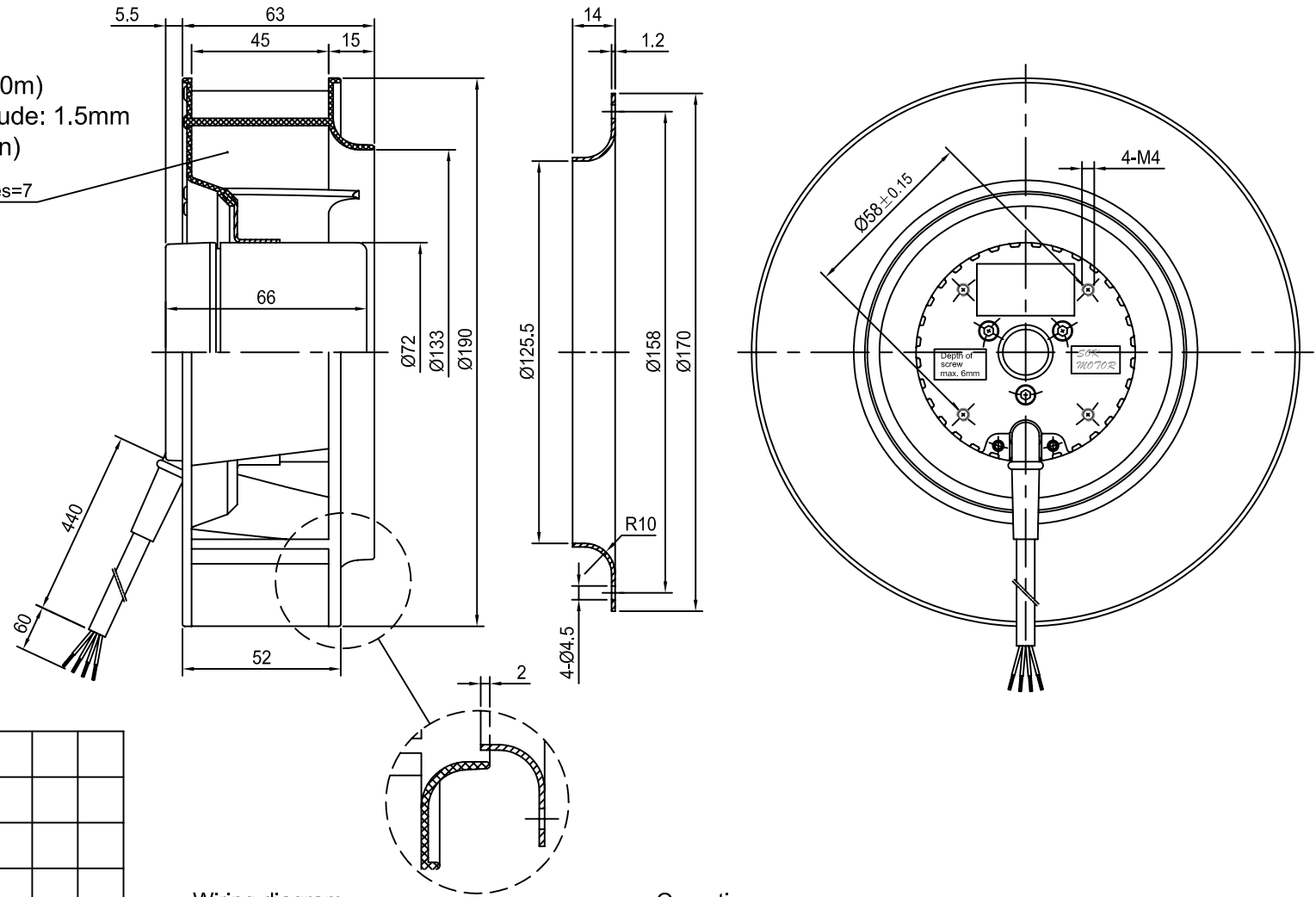

Specification

Code: S03-4
 EC Backward Curved Fan
 P/N: E1H190WY03-2

Suzhou SOK Motor Mfg. Co.,Ltd.